

SOLENOID VALVE

E5 Series

Cat No E5 - 01 - 01

3 / 2 Direct acting normally closed valve (17 mm)

Features

- Modular type valve
- Wide range of coil voltages
- Continuous duty cycle
- Low temperature of operation
- Noiseless performance
- Manual operator - Push type
- Gang mounting type

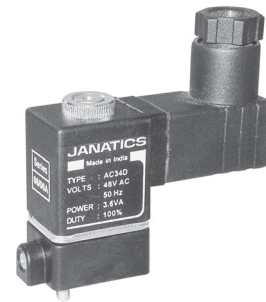

Technical Specifications

Model	E54004 *	
Ambient Temperature	5° - 60° C	
Medium	Filtered compressed air	
Orifice (NW)	1	
Operating pressure range	8 bar	
Flow rate @	35 lpm	
Electrical		
Coil width	17 mm	
Voltage (V) ± 10%	AC (50 Hz) 24, 48, 110, 220	DC 12, 24, 48, 110
Power consumption	3.6 VA	2.5 W
Duty cycle	Continuous	
Type of coil protection	IP65	
Class of insulation	Class F	
Materials of construction	Aluminium, Brass, Stainless steel, Nitrile, plastic	

@ Inlet pressure 6 bar, and pressure drop 1 bar

* For ordering No, voltage to be added. Refer how to ordering in page no. 10.2

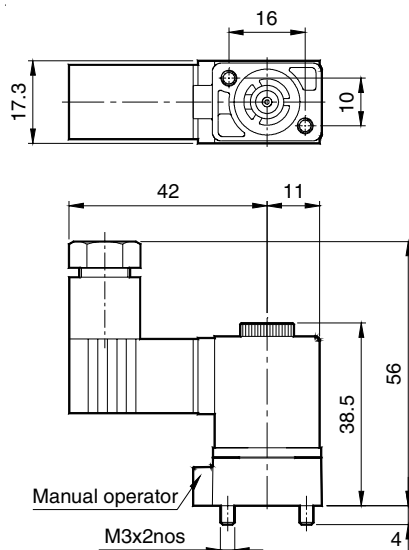

Drilling plane detail on mounting base

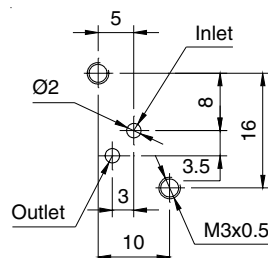

Caution:

A.C coil can be used on a D.C coil valve, and vice versa.

SOLENOID VALVE

E5 Series

Cat No E5 - 01 - 01

Manifold for single valve mounting

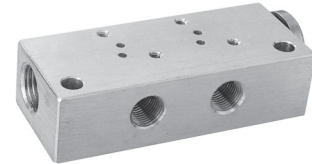
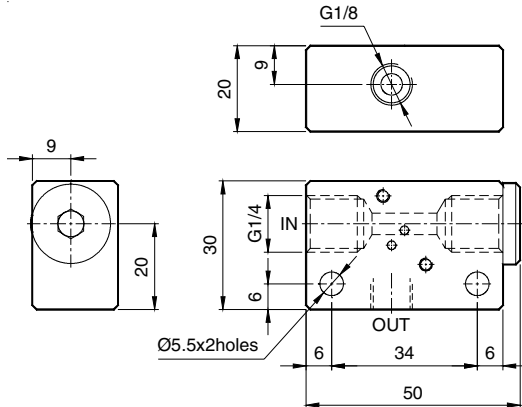

Manifold for 2, 4, 6, 8 valve mounting

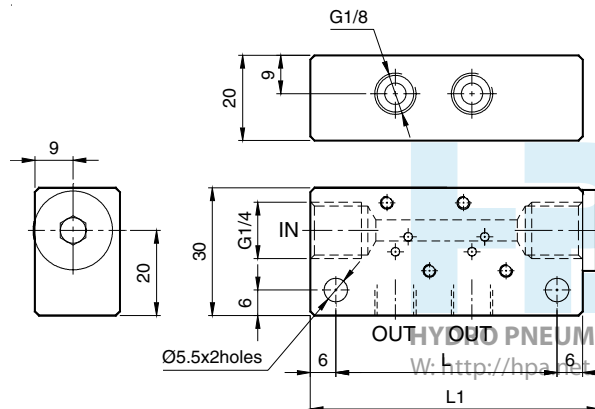

For mounting	L	L1	Ordering No.
1 valve	-	-	M170001
2 valves	52	68	M170002
4 valves	88	104	M170004
6 valves	124	140	M170006
8 valves	160	176	M170008

Cover plate assembly

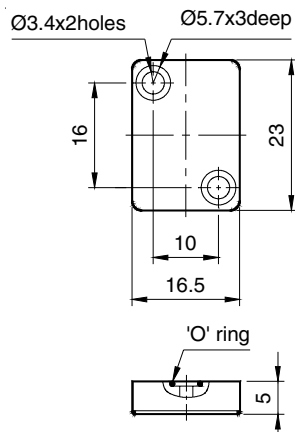

Application:

The cover plate assembly can be used to plug the unutilised position in a manifold.

For eg., if it is required to mount only 3 valves on manifold no. M170004, the fourth position can be plugged and made dummy using one cover plate assembly.

S. No.	Item	Qty	Ordering No
1	Cover plate	1	A3C02
2	O ring	1	
3	Screw - M3 x 6	2	

How to order

While ordering Solenoid operated valves, please mention this suffix along with the model number to indicate the required voltage

A	220V AC	Q	110V DC
B	110V AC	S	48V DC
D	48V AC	W	24V DC
G	24V AC	R	12V DC

Example

The ordering no. for 3/2 direct acting normally closed valve 17mm with 24V D.C coil is **E54004W**

Subject to change