



**PILOT OPERATED  
PRESSURE REDUCING VALVE  
PPM 06K**

**ENGINEERING**

**1**

**Ref. No. D 23100 B**  
Release 01/2004

**Description**

Two stage spool type Reducing valve cartridge

Two options for pressure adjustment,

- With set screw and lock nut.
- With hand knob and lock nut.



**Section**

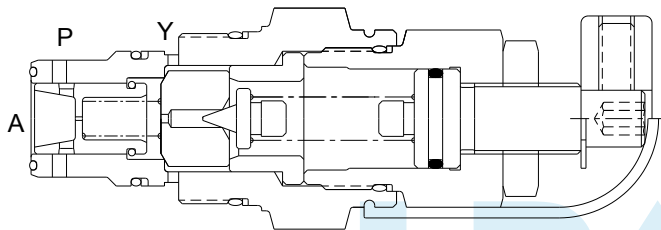

**Hydraulic Symbol**

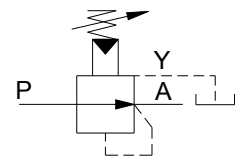

**Unit dimension**

**Threaded cartridge and cavity details**

HYDRO PNEUMATIC ACCESSORIES  
http://hpa.net.in E: inq@hpa.net.in

Dimensions in mm.

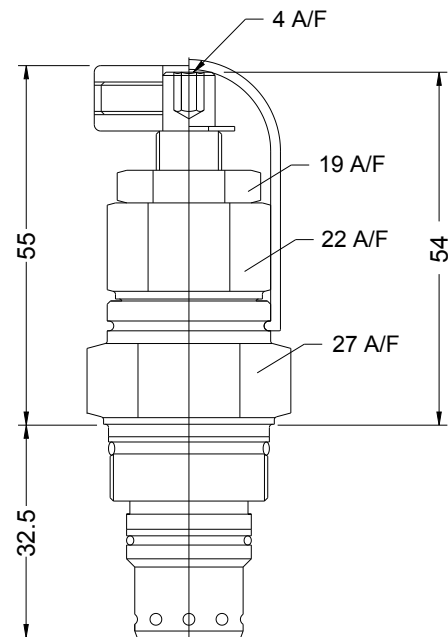
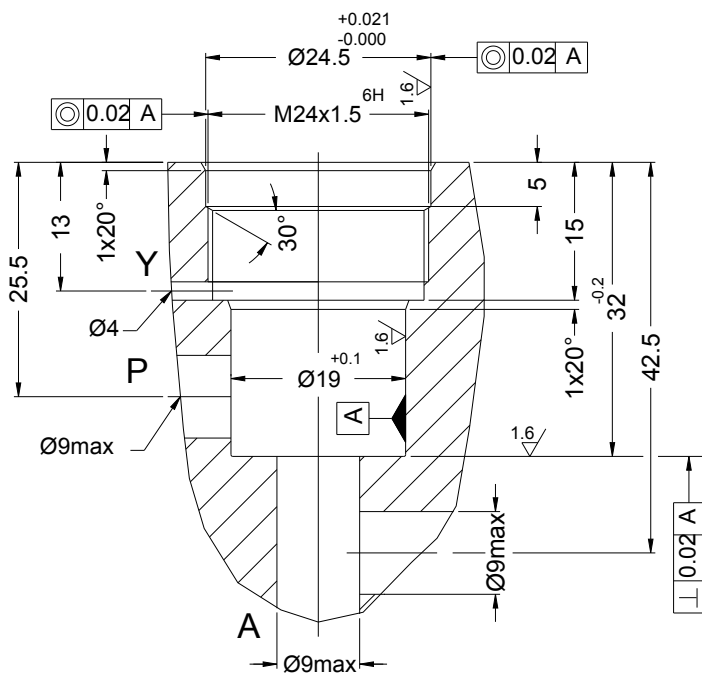
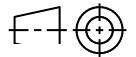

**Polyhydron Pvt. Ltd.**  
78-80, Machhe Industrial Estate,  
Machhe, Belgaum - 590 014. INDIA.

**Phone** : +91-(0)831-2411001  
**Fax** : +91-(0)831-2411002  
**E-mail** : polyhydron@vsnl.com  
**Website** : www.polyhydron.com



**PILOT OPERATED  
PRESSURE REDUCING VALVE  
PPM 06K**

**ENGINEERING**

**2**

**Ref. No. D 23100 B**

**Technical specification**

Construction .....	Pilot Operated Spool Type
Mounting .....	Threaded Cartridge, Factory standard.
Mounting position .....	Optional
Flow direction .....	From port P to A
Operating pressure .....	For port P ..... 315 bar
	For port A ..... 200 bar
	For port Y ..... 1 bar
Hydraulic medium .....	Mineral oil
Viscosity range .....	10 Cst to 380 Cst.
Fluid temperature range .....	-20 °C to +100 °C.
Fluid cleanliness requirement .....	As per ISO 16/13
Maximum flow handling capacity .....	30 lpm
Mass .....	0.2 kg.



**HYDRO PNEUMATIC ACCESSORIES**  
W: <http://hpa.net.in> E: [inq@hpa.net.in](mailto:inq@hpa.net.in)

**Ordering code**

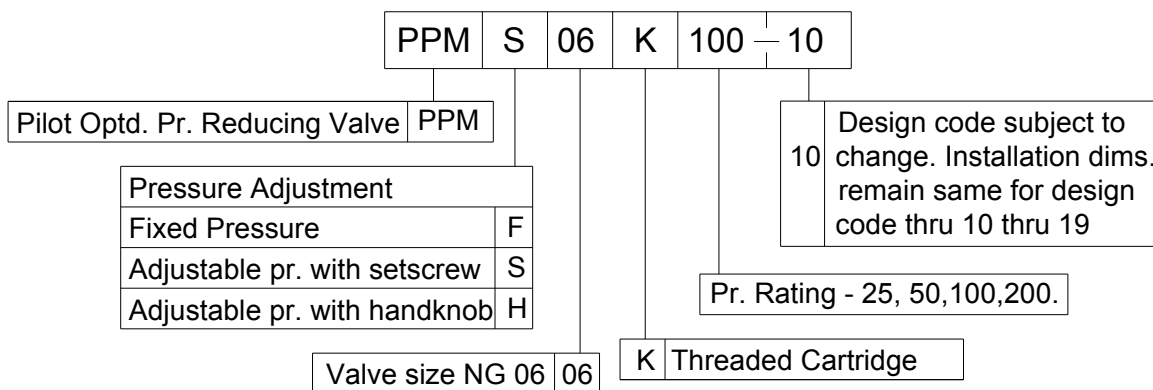



**PILOT OPERATED  
PRESSURE REDUCING VALVE  
PPM 06K**

**SERVICE**

**3**

**Ref. No. D 23100 B**

**Sectional view & Part details**

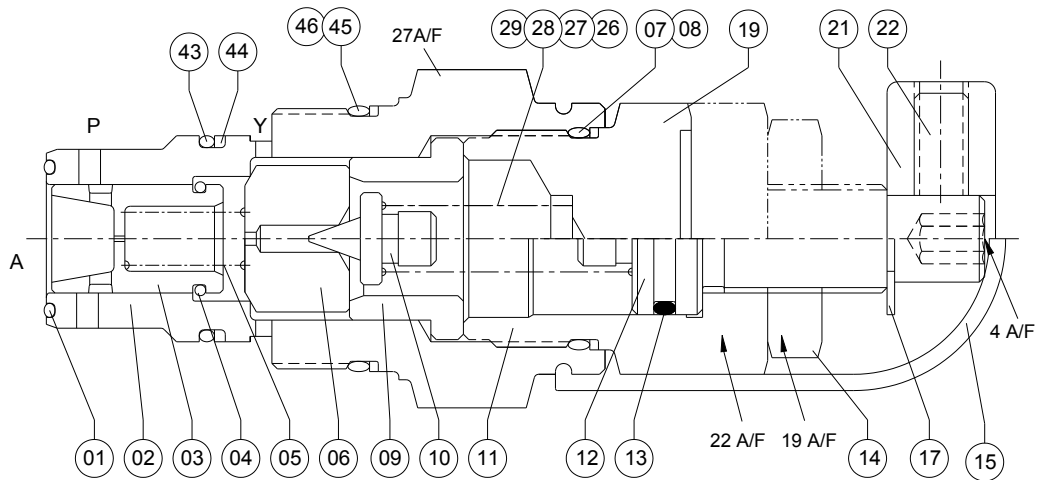

Sl no	Description	Part No	Qty
* 1	O'Ring Ø12.5 id x 1 csd	23101	1
2	Main Bush		1
3	Main Poppet		1
4	Spring ring Ø8 id X 1 csd		1
5	Spring		1
6	Pilot valve seat		1
* 7	O'Ring 17.5 ID x 1.5 CSD	23107	2
8	Back up ring 18 x 20.5 x 1 th	23108	2
9	Spacer		1
10	Pilot Poppet		1
11	Spring Casing		1
12	Adjusting screw		1
* 13	O'Ring Ø10.5 ID x 1.5 CSD	23113	1
14	Check Nut		1
15	Rubber Cap		1

Sl no	Description	Part No	Qty
17	Circlip `C' Type Ø6 Nominal	23117	1
19	Plug (Fixed Pr.)		1
21	Hand knob		1
22	Grub screw		2
# 26	Spring 25 bar	23126	1
# 27	" 50 bar	23127	1
# 28	" 100 bar	23128	1
# 29	" 200 bar	23129	1
43	O Ring (16 id x 1.5 csd)		1
44	Backup Ring (16 x 18.98 x 1)		1
45	O Ring (21 id x 1.5 csd)		1
46	Backup Ring (21 x 24.48 x 1)		1

Note : \* Recommended seal kit. \* & # Recommended spare kit.

While ordering the individual spares / spare kit / seal kit, give part no. and complete details of model code as on the label.