

## Description

Shut off valve model SLG, SLWG are two way, seat type valves.

These are used for isolating the oil flow in the direction as indicated by an arrow mark shown on the valve body.



## Section

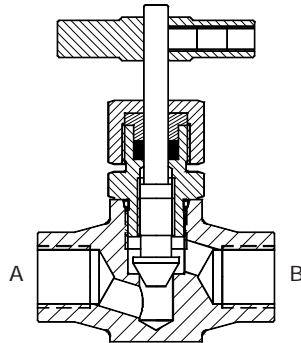

Hydraulic Symbol

## Unit Dimensions

In - line and Right angle bodies (With BSP ports)

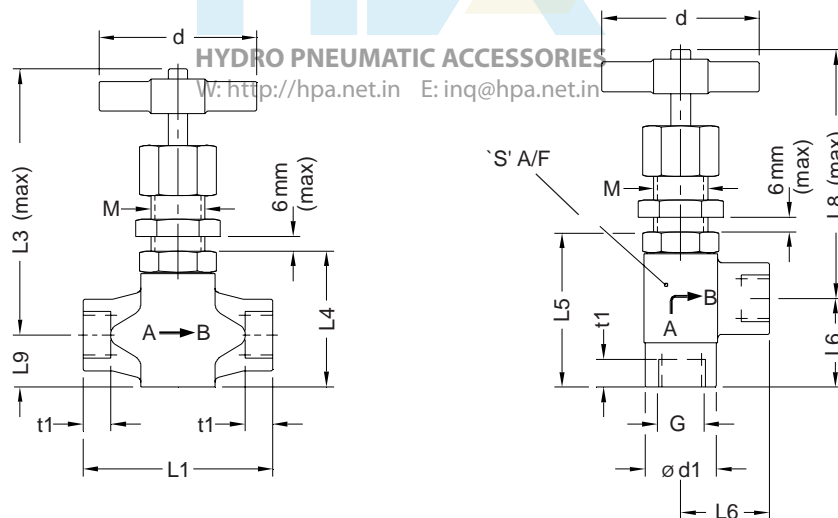

Table 1

Model Code In-line	Model Code Right angle	G	L1	L3	L4	L5	L6	L8	L9	d	t1	S	M
SLG02-2.0	SLWG02-2.0	G 1/4	70	110.5	54.5	56.5	30	103.5	21.0	64	14	30	M22x1.5
SLG03-2.0	SLWG03-2.0	G 3/8	70	110.5	54.5	56.5	30	103.5	21.0	64	14	30	M22x1.5
SLG04-2.0	SLWG04-2.0	G 1/2	77	110.5	54.5	62.5	36	103.5	21.0	64	17	30	M22x1.5
SLG06-2.0	SLWG06-2.0	G 3/4	93	122.0	71.0	77.0	45	110.0	27.0	84	17	36	M26x1.5
SLG08-2.0	SLWG08-2.0	G1	93	122.0	72.0	77.0	45	110.0	27.0	84	18	46	M26x1.5
SLG10-2.0	SLWG10-2.0	G1.1/4	162	162.0	105.0	113.0	65	143.0	51.5	120	22	60	M42x2.0
SLG12-2.0	SLWG12-2.0	G1.1/2	162	162.0	105.0	113.0	65	143.0	51.5	120	24	60	M42x2.0

# Shut off Valve - Inline and Right angle, Model : SLG, SLWG



the right connection

Ref. No : H04343, Release Jan 2006 (Dimensions in mm)

## Unit Dimensions

In - line and Right angle bodies (With Tube ends)

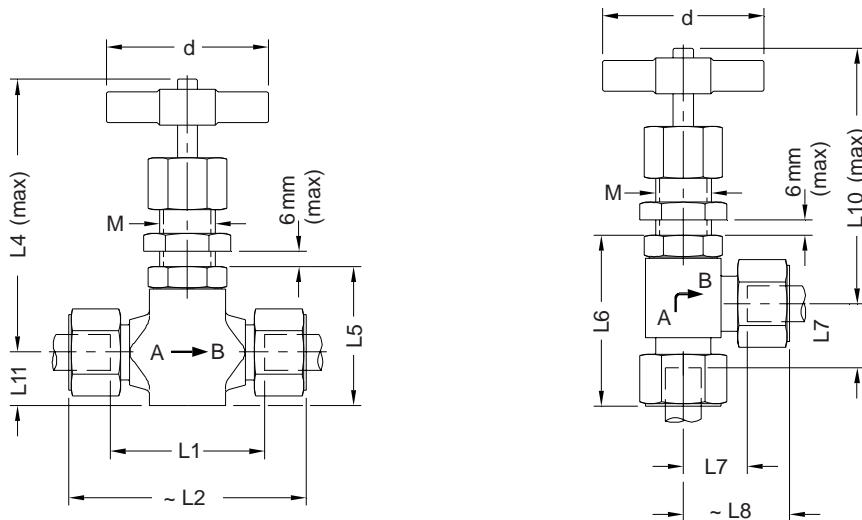

Table 2

Model Code In-line	Model Code Right angle	Tube OD	L1	L2	L4	L5	L6	L7	L8	L10	L11	d	S1	S2	M
SL10S-2.0	SLW10S-2.0	10	55	88.0	110.5	54.5	65.5	22.0	39.0	103.5	21	64	22	30	M22x1.5
SL12S-2.0	SLW12S-2.0	12	55	88.0	110.5	54.5	65.5	22.0	39.0	103.5	21	64	24	30	M22x1.5
SL16S-2.0	SLW16S-2.0	16	60	97.0	110.5	54.5	67.5	22.0	41.0	103.5	21	64	30	30	M22x1.5
SL20S-2.0	SLW20S-2.0	20	72	115.0	122.0	71.5	77	28.0	68.0	110	28	84	36	41	M26x1.5
SL25S-2.0	SLW25S-2.0	25	69	117.0	122.0	71.5	82.5	28.0	73.5	110	28	84	46	41	M26x1.5
SL30S-2.0	SLW30S-2.0	30	135	188.0	162.0	118.0	111	40.0	63.0	143	52	120	50	60	M42x2.0
SL38S-2.0	SLW38S-2.0	38	130	192.0	162.0	118.0	115	40.0	67.0	143	52	120	60	60	M42x2.0

### HYDRO PNEUMATIC ACCESSORIES

W: <http://hpa.net.in> E: [inq@hpa.net.in](mailto:inq@hpa.net.in)

## Technical Specifications

- Construction . . . . . Seat type valve.
- Mounting style . . . . . In-line or Right angle body, line mounted.
- Mounting position . . . . . Optional.
- Flow direction . . . . . As indicated by an arrow on valve body.
- Operating pressure . . . . . 350 bar.
- Hydraulic medium . . . . . Mineral oil.
- Viscosity range . . . . . 10 cSt to 380 cSt.
- Fluid temperature range . . . . . -20 °C to +80 °C.
- Fluid cleanliness requirement . . . . . As per ISO 19/16 or better.
- Maximum flow handling capacity . . . . . Refer graph.

## Performance Curves

Oil used : ISO VG 68,  
 Viscosity : 68 cSt @ 40 °C  
 Test conducted at : 50 °C.

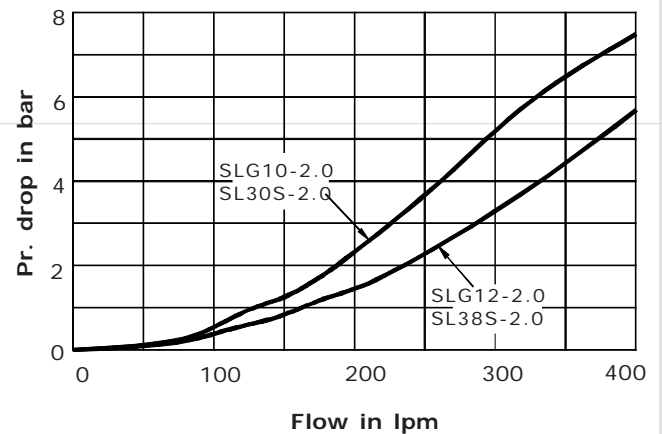
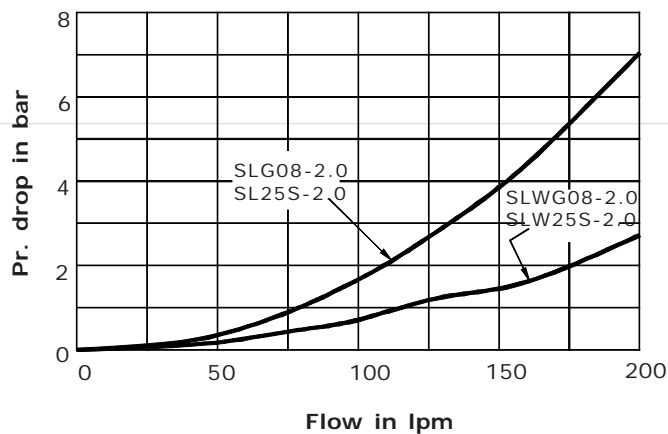
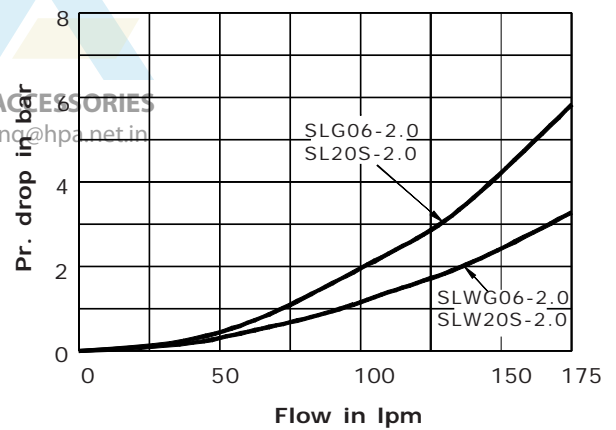
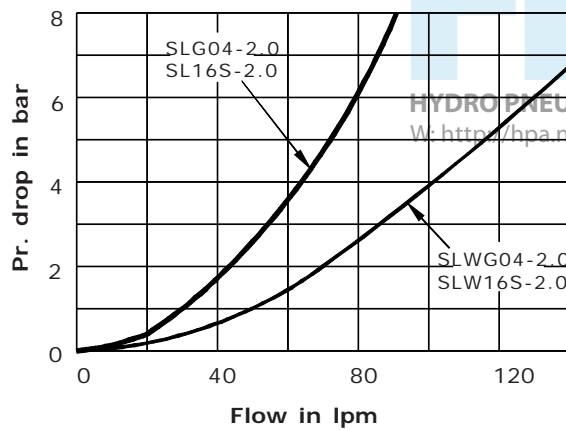
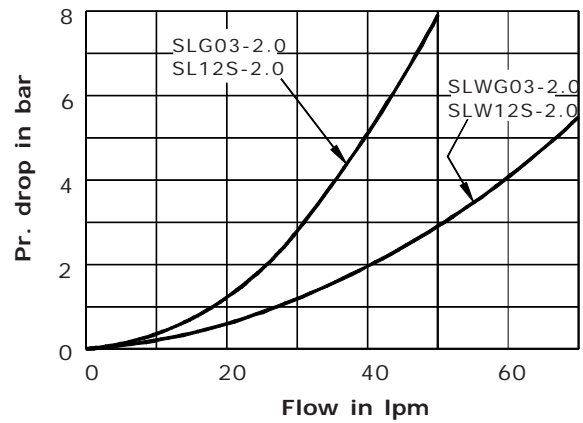
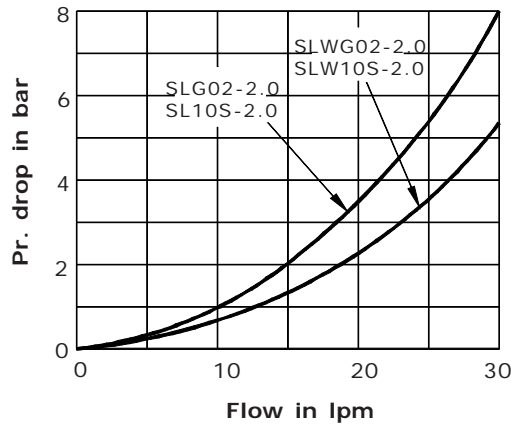

# Shut off Valve - Inline and Right angle, Model : SLG, SLWG



the right connection

Ref. No : H04343, Release Jan 2006 (Dimensions in mm)

## Ordering Code

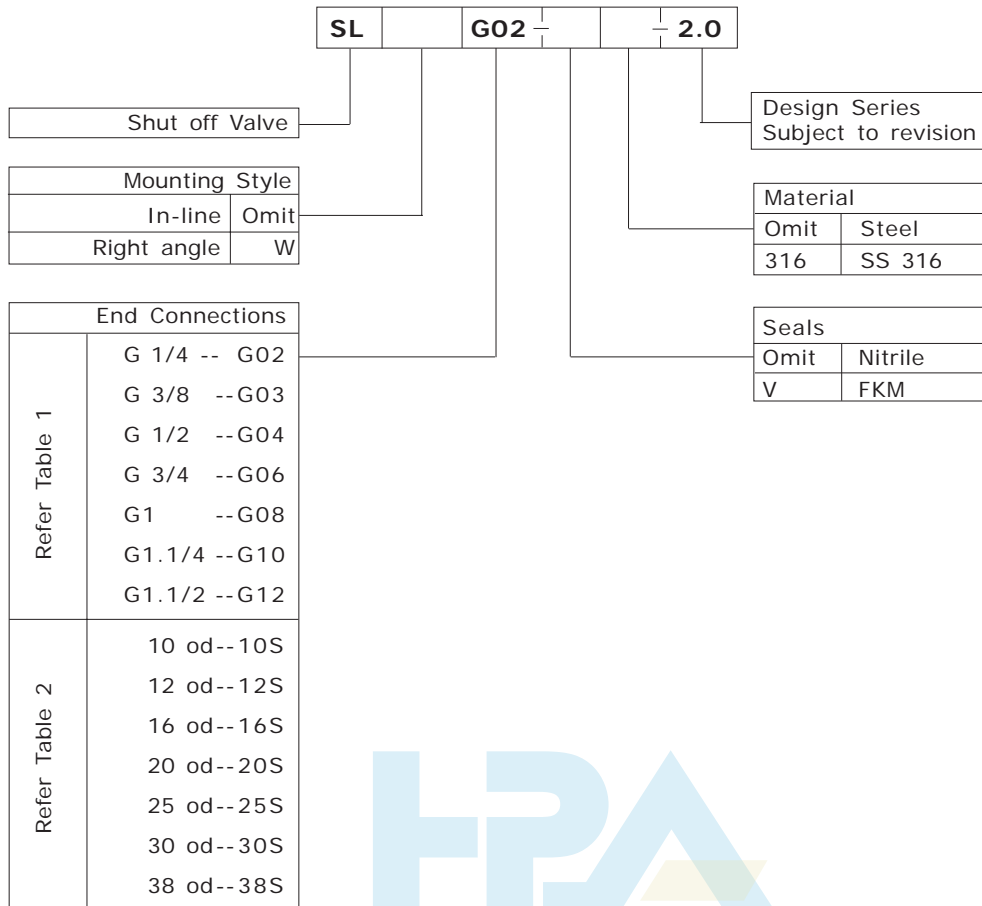

**HYDRO PNEUMATIC ACCESSORIES**

W: <http://hpa.net.in> E: [inq@hpa.net.in](mailto:inq@hpa.net.in)